

# RM6



## Double-Sided 6-Corner Shoulder Milling Tool

Milling tool series for high quality surface finish and cost efficiency

- ▣ **Higher Productivity**

Designed to provide high speed and feed improves chip removal rates

- ▣ **Improved Perpendicularity**

True perpendicular milling

- ▣ **Superior Clamping Stability**

Powerful clamping thanks to strong clamping screws and 3-side flank supporting system



## Double-Sided 6-Corner Shoulder Milling Tool

# RM6

Mold making companies are required to keep up with the demands of the accelerated development of Industrial structures.

**RM6**, KORLOY's new Rich Mill Series for shouldering responds to these demands by employing double-sided inserts with six perpendicular corners to achieve cost efficiency.

It features strong clamping screws, 3-side supporting system, and wide clamping areas which enable powerful clamping force. This facilitates stable machining at high speed and feed, and delivers higher productivity.

Wide minor cutting edges and optimized multi-stepped relief surfaces of the RM6 provide exceptional bottom surface finish. The RM6 achieves perpendicularity and improved flank surface finish. The chip breaker design high rake and high helix angle were applied to the inserts for stable cutting performance in hard-to-cut materials or high hardened workpieces, achieving an increase in tool life.

KORLOY's RM6 is one of the most advanced shouldering solutions available to meet the demand of the mold making market today.

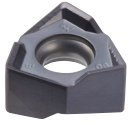

Insert



Cutter



Shank

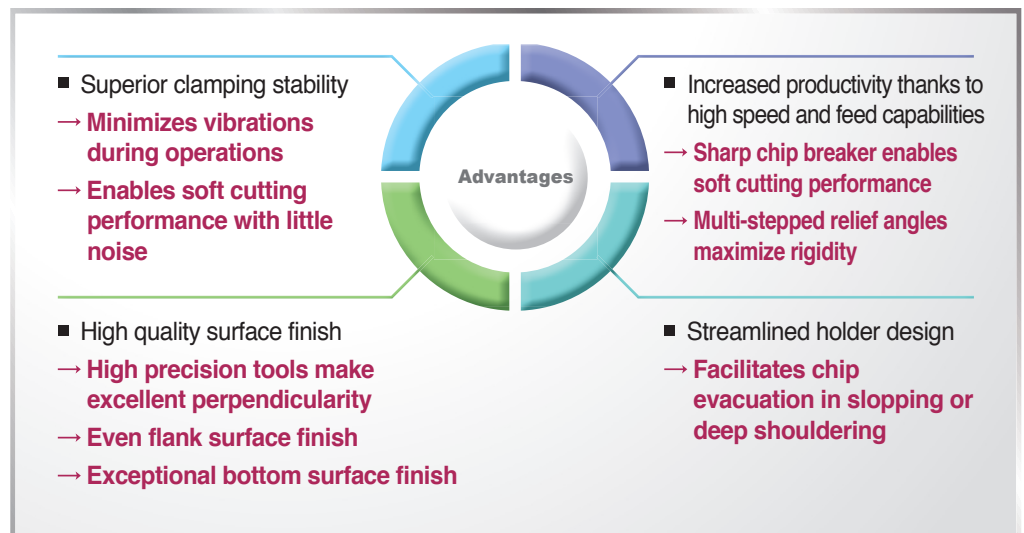

### Code System

[ Insert shape ]

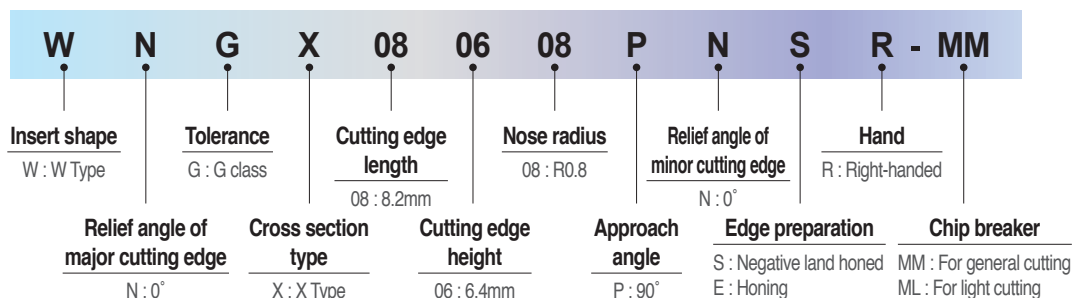

## Code System

[ Shank Type ]

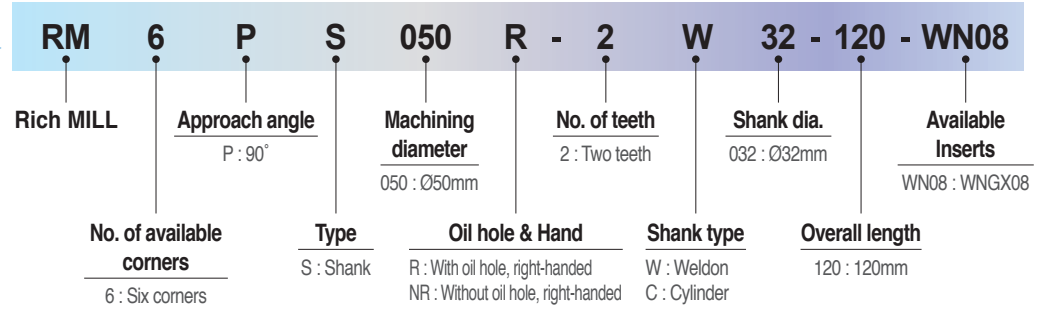

[ Cutters type ]

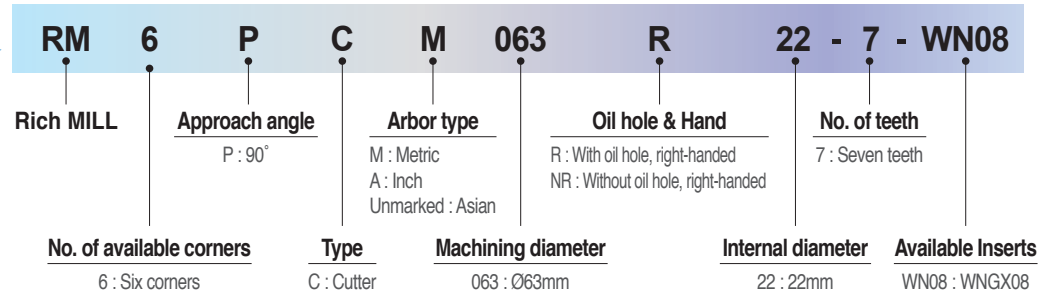

## RM6 Features

- **Stable clamping** - 3 clamping surfaces on the side and strong clamping screws  
→ Improves cutting stability
- **High quality results** - High precision, excellent perpendicularity, outstanding surface finish on the flank, accurate tolerance
- **High productivity** - High rake angle and sharp cutting edges for lower cutting resistance  
→ Ideal for high speed and high feed machining

## Insert Features

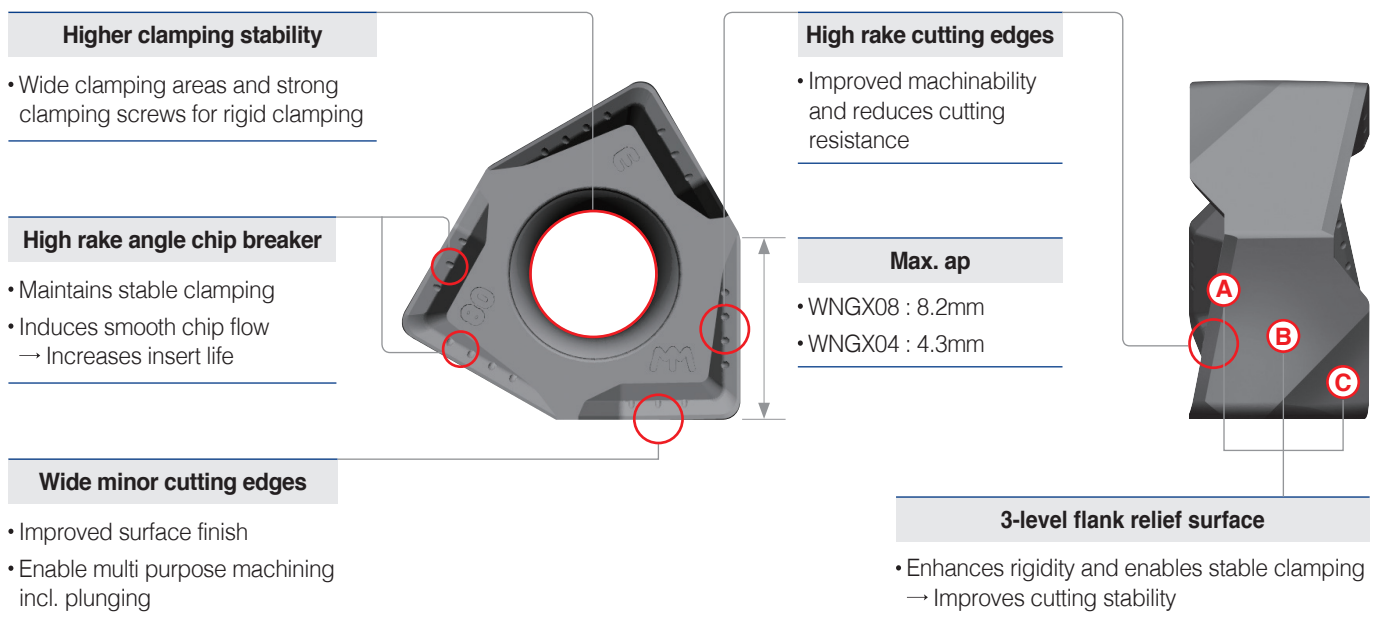

## ⇒ Cutter Features

- 3-side supporting system, strong clamping screws, and wide seat areas
  - **Improve clamping stability**
  - **Reduce tool vibrations and cutting resistance**
- Optimized H/D design with curved surface for smooth chip flow
  - **Facilitates chip evacuation in slopping or deep shouldering**

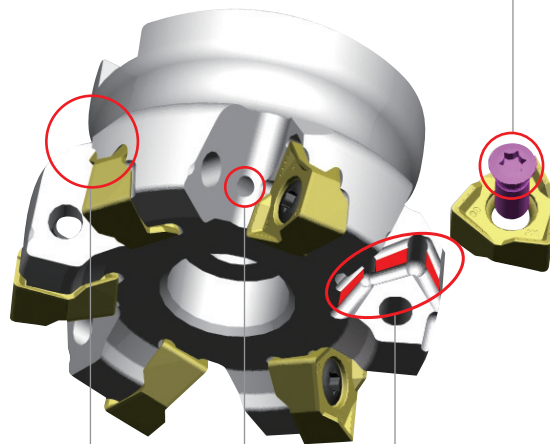

### Strong clamping screws

- Strong clamping screws enable rigid clamping

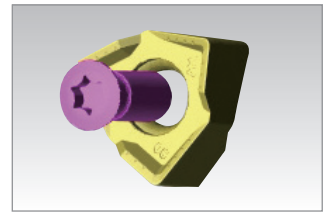

### Streamlined holder design

- Improved chip evacuation in deep shouldering and slotting

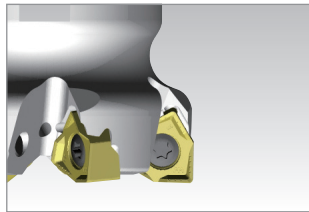

### Through coolant system

- Improved chip flow and tool life thanks to insert cooling

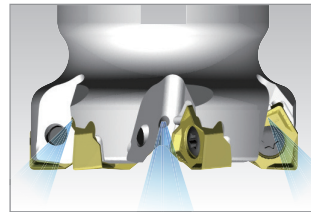

### 3-side supporting system

- Stable tool life



## ⇒ Chip Breaker Features

- Chip breaker **MA**



- Chip breaker **ML**



- Chip breaker **MM**



Chip breaker	Cutting edge	Application	Features
MA		For aluminum	<ul style="list-style-type: none"> <li>■ MA : Milling Aluminum</li> <li>■ Sharp cutting edges for excellent cutting performance in aluminum machining</li> <li>■ Buffed surface for excellent chip flow and welding resistance</li> </ul>
ML		For light cutting	<ul style="list-style-type: none"> <li>■ ML : Milling Light</li> <li>■ Chip breaker design of low cutting resistance, ideal for light cutting and machining hard-to-cut materials</li> <li>■ Excellent tool life and quality results</li> </ul>
MM		For general cutting	<ul style="list-style-type: none"> <li>■ MM : General shouldering operations</li> <li>■ Chip breaker design ideal for general shoulder milling and most applications</li> </ul>



## ⇒ Performance Evaluation

- Workpiece 42CrMo4(DIN), SCM440(KS), 4140(AISI), 300(L)x200(W)x100(H), Steel rectangular tube
- Cutting conditions  $vc(m/min)=250$ ,  $fz(mm/t)=0.2$ ,  $ap(mm)=4$ ,  $ae(mm)=10$ , Dry
- Machining method Facing
- Tools Insert WNGX080608PNSR-MM(PC5300) Holder RM6PCM063R-22-6-WN08

• Chipping resistance has improved thanks to stable clamping even at high speed

→ **Minimized unexpected tool breakage**

• Sharp cutting edges and streamlined chip breaker design

→ **Minimized cutting resistance**

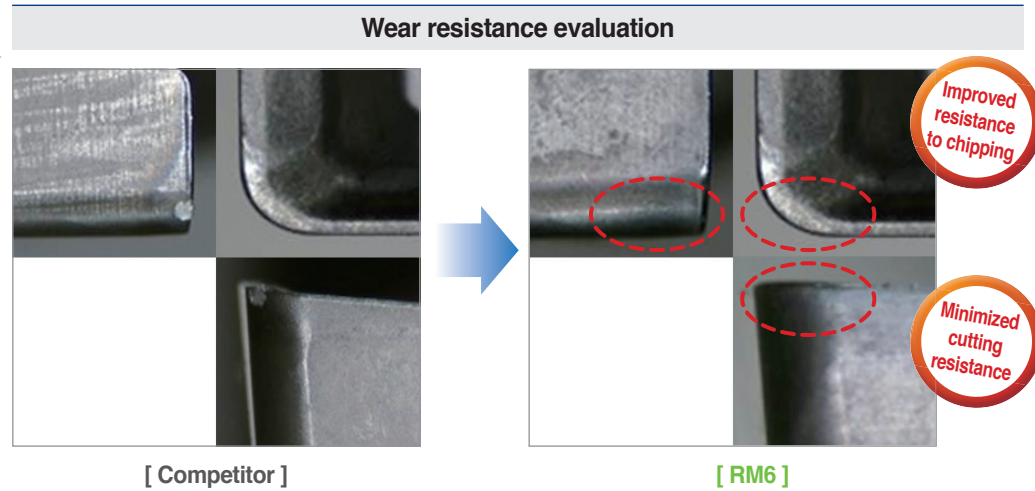

## ⇒ Perpendicularity Evaluation

- Workpiece C45(ISO), SM45C(KS), 1045(AISI), 300(L)x200(W)x100(H), Steel rectangular tube
- Cutting conditions  $vc(m/min)=150$ ,  $fz(mm/t)=0.15$ ,  $ap(mm)=7$ ,  $ae(mm)=5$ , Dry
- Machining method Perpendicularity, flank surface finish, and unevenness were measured after three passes of 7mm each, and 21mm in total
- Tools Insert WNGX080608PNSR-MM(PC5300) Holder RM6PCM063R-22-6-WN08

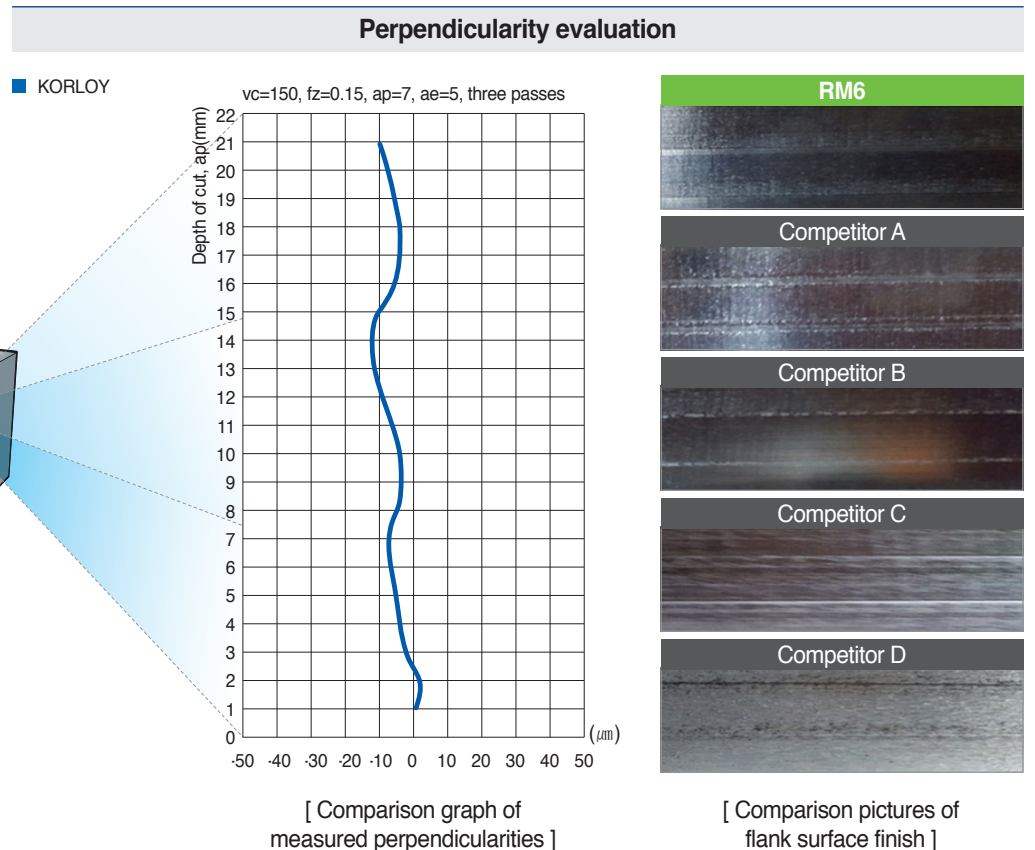

## ⇒ Application Examples

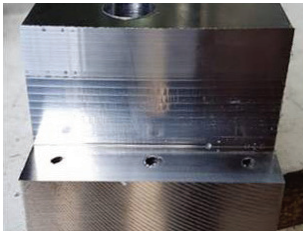

### Carbon steel [C45(ISO), HB180]

- Cutting conditions vc(m/min)=250, fz(mm/t)=0.12, ap(mm)=7, ae(mm)=2, Dry
- Machining method Shouldering
- Tools Insert WNGX080608PNSR-MM(PC5300)  
Holder RM6PS032R-2W32-120-WN08



➔ 50% longer tool life compared to the competitor



### Cold forged tool steel [X100CrMoV5 1(DIN), HB255]

- Cutting conditions vc(m/min)=235, fz(mm/t)=0.28, ap(mm)=2, ae(mm)=5, Dry
- Machining method Shouldering
- Tools Insert WNGX080608PNER-ML(PC5300)  
Holder RM6PCM063R-22-6-WN08



➔ 64% longer tool life compared to the competitor



### Cast iron [600-3(ISO), HB230]

- Cutting conditions vc(m/min)=226, fz(mm/t)=0.19, ap(mm)=1, ae(mm)=75, Dry
- Machining method Facing
- Tools Insert WNGX080608PNER-ML(PC5400)  
Holder RM6PCM080R-27-7-WN08



➔ 20% longer tool life compared to the competitor



## Grade Guideline per Workpiece Type

Cutting conditions		Workpiece	P		M	K	N
			Carbon steel	Alloy steel	Stainless steel	Cast iron	Non-ferrous metal
Shape	1st recommended		MM	MM	ML	ML	MA
	2nd recommended		ML	ML	-	MM	MA
Grade	High speed milling		PC3600	PC3600	PC5300	PC6510	H01
	General milling		PC5400	PC5300	PC5400	PC5300	H01
	Interrupted milling		PC5400	PC5400	PC5400	PC5400	H01

## Recommended Cutting Conditions

### WNGX04

Workpiece	Grade	WNGX040304PNSR-MM			WNGX040304PNER-ML			WNGX040304PNFR-MA			
		vc (m/min)	fz (mm/t)	max. ap(mm)	vc (m/min)	fz (mm/t)	max. ap(mm)	vc (m/min)	fz (mm/t)	max. ap(mm)	
P	Steel	PC3600	160~270	0.25~0.05	4.3	160~270	0.20~0.05	4.3	-	-	-
		PC5300	150~240	0.25~0.05		150~240	0.25~0.05		-	-	-
		PC5400	130~210	0.25~0.05		130~210	0.25~0.05		-	-	-
M	Stainless steel	PC5300	90~150	0.20~0.05	4.3	90~150	0.10~0.05	4.3	-	-	-
		PC5400	70~120	0.20~0.05		70~120	0.10~0.05		-	-	-
K	Cast iron	PC6510	140~230	0.30~0.08	4.3	140~230	0.25~0.08	4.3	-	-	-
		PC5300	120~200	0.30~0.08		120~200	0.25~0.08		-	-	-
N	Non-ferrous metal	H01	-	-	-	-	-	-	500~1000	0.2~0.05	4.3

\* The above data refer to general cutting conditions and can be adjustable up to 300m/min and 0.4mm/t depending on user environment.

### WNGX08

Workpiece	Grade	WNGX080608PNSR-MM			WNGX080608PNER-ML			WNGX080608PNFR-MA			
		vc (m/min)	fz (mm/t)	max. ap(mm)	vc (m/min)	fz (mm/t)	max. ap(mm)	vc (m/min)	fz (mm/t)	max. ap(mm)	
P	Steel	PC3600	160~270	0.25~0.05	8.2	160~270	0.20~0.05	8.2	-	-	-
		PC5300	150~240	0.25~0.05		150~240	0.25~0.05		-	-	-
		PC5400	130~210	0.25~0.05		130~210	0.25~0.05		-	-	-
M	Stainless steel	PC5300	90~150	0.20~0.05	8.2	90~150	0.10~0.05	8.2	-	-	-
		PC5400	70~120	0.20~0.05		70~120	0.10~0.05		-	-	-
K	Cast iron	PC6510	140~230	0.30~0.08	8.2	140~230	0.25~0.08	8.2	-	-	-
		PC5300	120~200	0.30~0.08		120~200	0.25~0.08		-	-	-
N	Non-ferrous metal	H01	-	-	-	-	-	-	500~1000	0.2~0.05	8.2

\* The above data refer to general cutting conditions and can be adjustable up to 300m/min and 0.4mm/t depending on user environment.

## ➔ Ramping

1. Ramping

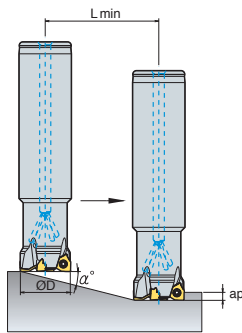

2. Helical cutting for blind holes

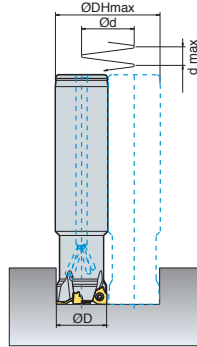

3. Helical cutting for through holes

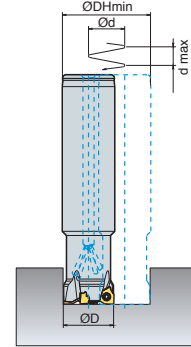

(mm)

Designation	Tool Dia. ØD	Depth of cut ap	1. Ramping		2. Helical cutting for blind holes				3. Helical cutting for through holes		
			Max. rake angle α°	Lmin	Min. machining Dia. Ø DHmin	Max. pitch dmax	Max. machining Dia. Ø DHmax	Max. pitch dmax	Min. machining Dia. Ø DHmin	Max. pitch dmax	
RM6PS	032R-2W32-120-WN08	32	8	4.6	99.5	54	4.5	62	5.2	38.5	3.2
	040R-3W32-120-WN08	40	8	4.2	109	69	5.3	78	6.0	54.5	4.2
	050R-4W32-120-WN08	50	8	4.0	114.5	89	6.5	98	7.2	74.5	5.5
RM6PCM	063R-22-6-WN08	63	8	4.0	114.5	115	8.0	124	8.0	100.5	7.4
	080R-27-7-WN08	80	8	3.5	131	149	8.0	158	8.0	134.5	8.0
	100R-32-8-WN08	100	8	2.6	176.5	189	8.0	198	8.0	174.5	8.0
	125R-40-11-WN08	125	8	1.8	255	239	8.0	248	8.0	224.5	7.8

\* Lmin = ap/tan(α°)

Lmin : Cutting length at min. rake angle  
ap : Axial depth of cut  
α° : Available rake angle for ramping

## ➔ Available Inserts

(mm)

Shape	Designation	Coated					Dimensions (mm)				Figure	
		PC3600	PC5300	PC5400	PC6510	Uncoated H01	d	t	r	Max. ap		
	WNGX	040304PNFR-MA					7.0	3.46	0.4	4.3		
		040308PNFR-MA					7.0	3.46	0.8	4.3		
		040312PNFR-MA					7.0	3.46	1.2	4.3		
		040316PNFR-MA					7.0	3.46	1.6	4.3		
		080604PNFR-MA					13.0	6.4	0.4	8.2		
		080608PNFR-MA					●	13.0	6.4	0.8		8.2
		080612PNFR-MA						13.0	6.4	1.2		8.2
		080616PNFR-MA						13.0	6.4	1.6		8.2
		080620PNFR-MA						13.0	6.4	2.0		8.2
	WNGX	040304PNER-ML					7.0	3.46	0.4	4.3		
		040308PNER-ML					7.0	3.46	0.8	4.3		
		040312PNER-ML					7.0	3.46	1.2	4.3		
		040316PNER-ML					7.0	3.46	1.6	4.3		
		080604PNER-ML	●	●	●		13.0	6.4	0.4	8.2		
		080608PNER-ML	●	●	●		13.0	6.4	0.8	8.2		
		080612PNER-ML					13.0	6.4	1.2	8.2		
		080616PNER-ML					13.0	6.4	1.6	8.2		
		080620PNER-ML					13.0	6.4	2.0	8.2		
	WNGX	040304PNSR-MM					7.0	3.46	0.4	4.3		
		040308PNSR-MM					7.0	3.46	0.8	4.3		
		040312PNSR-MM					7.0	3.46	1.2	4.3		
		040316PNSR-MM					7.0	3.46	1.6	4.3		
		080604PNSR-MM	●	●			13.0	6.4	0.4	8.2		
		080608PNSR-MM	●	●			13.0	6.4	0.8	8.2		
		080612PNSR-MM					13.0	6.4	1.2	8.2		
		080616PNSR-MM					13.0	6.4	1.6	8.2		
		080620PNSR-MM					13.0	6.4	2.0	8.2		



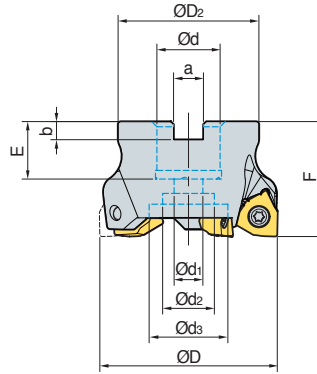
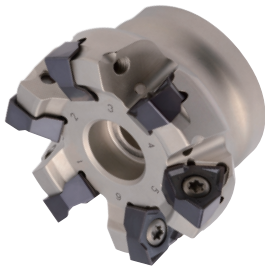
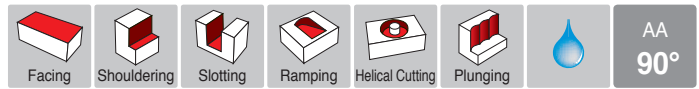

(mm)

Designation			ØD	ØD <sub>2</sub>	Ød	Ød <sub>1</sub>	Ød <sub>2</sub>	Ød <sub>3</sub>	a	b	E	F	ap	
RM6PCM	040R-16-6-WN04	6	40	35	16	9	14	-	8.4	5.6	19	40	4.3	0.19
	040R-16-7-WN04	7	40	35	16	9	14	-	8.4	5.6	19	40	4.3	0.19
	050R-22-8-WN04	8	50	42	22	11	18	-	10.4	6.3	20	40	4.3	0.28
	050R-22-9-WN04	9	50	42	22	11	18	-	10.4	6.3	20	40	4.3	0.28
	063R-22-10-WN04	10	63	49	22	11	18	-	10.4	6.3	20	40	4.3	0.47
	063R-22-11-WN04	11	63	49	22	11	18	-	10.4	6.3	20	40	4.3	0.47
	050R-22-4-WN08	4	50	42	22	11	18	-	10.4	6.3	20	40	8.2	0.28
	050R-22-5-WN08	5	50	42	22	11	18	-	10.4	6.3	20	40	8.2	0.27
	063R-22-5-WN08	5	63	49	22	11	18	-	10.4	6.3	20	40	8.2	0.45
	063R-22-6-WN08	6	63	49	22	11	18	-	10.4	6.3	20	40	8.2	0.45
	080R-27-7-WN08	7	80	57	27	14	20	35	12.4	7	23	50	8.2	0.90
	080R-27-9-WN08	9	80	57	27	14	20	35	12.4	7	23	50	8.2	0.89
	100R-32-8-WN08	8	100	67	32	18	26	42	14.4	8	25	50	8.2	1.47
	100R-32-11-WN08	11	100	67	32	18	26	42	14.4	8	25	50	8.2	1.45
	125R-40-11-WN08	11	125	90	40	22	32	52	16.4	10	29	63	8.2	2.94
125R-40-14-WN08	14	125	90	40	22	32	52	16.4	10	29	63	8.2	2.91	
RM6PC	080R-25.4-7-WN08	7	80	57	25.4	14	20	35	9.5	6	25	50	8.2	0.91
	080R-25.4-9-WN08	9	80	57	25.4	14	20	35	9.5	6	25	50	8.2	0.91
	100R-31.75-8-WN08	8	100	67	31.75	18	26	42	12.7	8	32	63	8.2	1.69
	100R-31.75-11-WN08	11	100	67	31.75	18	26	42	12.7	8	32	63	8.2	1.73
	125R-38.1-11-WN08	11	125	90	38.1	22	32	52	15.9	9	35	63	8.2	1.98
	125R-38.1-14-WN08	14	125	90	38.1	22	32	52	15.9	9	35	63	8.2	2.90

### Available Arbors

Cutter designation	NC arbors
RM6PCM 040R-16-6-WN04	BT□□-FMC16-□□
040R-16-7-WN04	
050R-22-8-WN04	BT□□-FMC22-□□
050R-22-9-WN04	
063R-22-10-WN04	
063R-22-11-WN04	
050R-22-4-WN08	
050R-22-5-WN08	
063R-22-5-WN08	
063R-22-6-WN08	



Cutter designation	NC arbors
RM6PCM 080R-27-7-WN08	BT□□-FMC27-□□
080R-27-9-WN08	
100R-32-8-WN08	BT□□-FMC32-□□
100R-32-11-WN08	
125R-40-11-WN08	
125R-40-14-WN08	BT□□-FMC40-□□
RM6PC 080R-25.4-7-WN08	BT□□-FMA25.4-□□
080R-25.4-9-WN08	
100R-31.75-8-WN08	BT□□-FMA31.75-□□
100R-31.75-11-WN08	
125R-38.1-11-WN08	BT□□-FMA38.1-□□
125R-38.1-14-WN08	

### Parts

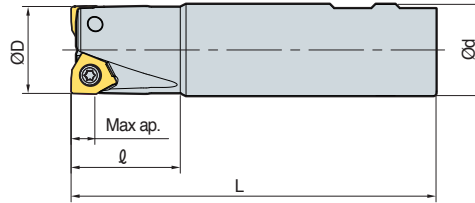

Specification		Screw	Wrench	Wrench
WNGX04	Ø40 ~ Ø63	ETNA02506	TW07S	-
WNGX08	Ø50 ~ Ø125	FTNA0512	-	TW20-100



(mm)

Designation			ØD	Ød	ℓ	L	ap	
<b>RM6PS</b>	020R-2W20-110-WN04	2	20	20	35	110	4.3	0.22
	020R-3W20-110-WN04	3	20	20	35	110	4.3	0.22
	025R-3W25-110-WN04	3	25	25	35	110	4.3	0.36
	025R-4W25-110-WN04	4	25	25	35	110	4.3	0.35
	032R-5W32-110-WN04	5	32	32	35	110	4.3	0.60
	032R-6W32-110-WN04	6	32	32	35	110	4.3	0.60
	032R-2W32-120-WN08	2	32	32	40	120	8.2	0.65
	040R-3W32-120-WN08	3	40	32	40	120	8.2	0.69
	040R-4W32-120-WN08	4	40	32	40	120	8.2	0.69
	050R-4W32-120-WN08	4	50	32	40	120	8.2	0.76
	050R-5W32-120-WN08	5	50	32	40	120	8.2	0.76

**Parts**

Specification		Screw 	Wrench 	Wrench 
<b>WNGX04</b>	Ø20 ~ Ø32	ETNA02506	TW07S	-
<b>WNGX08</b>	Ø32 ~ Ø50	FTNA0512	-	TW20-100



Holystar B/D, 1350, Nambusunhwan-ro, Geumcheon-gu, Seoul, 08536, Korea  
 Tel : +82-2-522-3181 Fax : +82-2-522-3184, +82-2-3474-4744 Web : www.korloy.com E-mail : export@korloy.com

**KORLOY AMERICA**

620 Maple Avenue, Torrance, CA 90503, USA  
 Tel : +1-310-782-3800 Toll Free : +1-888-711-0001 Fax : +1-310-782-3885  
 www.korloyamerica.com E-mail : sales@korloy.us

**KORLOY INDIA**

Plot NO.415, Sector 8, IMT Manesar, Gurgaon 122051, Haryana, INDIA  
 Tel : +91-124-4391790 Fax : +91-124-4050032  
 www.korloyindia.com E-mail : sales.kip@korloy.com

**KORLOY EUROPE**

Gablونzer Str. 25-27, 61440 Oberursel, Germany  
 Tel : +49-6171-277-83-0 Fax : +49-6171-277-83-59  
 www.korloyeurope.com E-mail : sales@korloyeurope.com

**KORLOY BRASIL**

Av. Aruana 280, conj.12, WLC, Alphaville, Barueri,  
 CEP06460-010, SP, Brasil  
 Tel : +55-11-4193-3810 E-mail : vendas@korloy.com